



AC Hydraulic^{A/S}

NO COMPROMISE



SD20L/SD26L SD20PHL/SD26PHL SD20PHL-A/SD26PHL-A

- Ⓚ Ophængsliste for saksedonkrafte
- Ⓜ Support arms for jacking beams
- Ⓛ Aufhängungen für Scherenheber
- Ⓛ Jeux d'accroches pour traverses de levage

Lift	Model, type, (evt. årgang og andre bemærkninger)	Varenr.
Lift	Model, Type, (Year and other comments)	Item No.
Hebebühne	Modell, Typ, (Baujahr und weitere Hinweise)	Artikel Nr.
Pont	Modèle, Marque (année et d'autres remarques)	Référence
Autec	3044, 4044	62 262 00
ATH Heintl	ATH 4.35A, ATH4.55A, ATH 4.35, ATH 4,55 (production 2013)	62 276 00
	ATH SH5000HA (production 2013)	62 354 00
AGM	M40, M45	62 270 00
ATT	AD H2 034 A, 3500 PH Accura 4700 mm	62 268 00
	HYMAX 5000 II	62 270 00
Autop	2.30, F 420 ***)	62 270 00
	2.40 F460	62 264 10
	Masterlift, Quattrolift, 4.60 F550 (Biglift), Profilift 2,4F, Profilift 2,4FN 460	62 264 00
Beissbarth	R420, R435	62 262 00
	BC 345	62 289 00
	Romeico 440	62 359 00
Bendpak	HD9, HD14	62 293 20
Bima	50	62 283 00
Bradbury	410, 414, 420, 424, 434	62 265 00
	"Flush-Fitt" modeller, models, Modellen, modèles	62 273 00
Cascos	C425, C444, C445, C450, C443 (standard) (med opbukket kant, with bent up edges, mit hochgebogener Kante, avec bord plié)	62 262 00
	C440, C444, C445, C450 (uden opbukket kant, without bent up edges, ohne hochgebogener Kante, sans bord plié)	62 265 00
	C441, C442, C443 (MOT), C445H	62 273 00
Consul	4.35 (H 152) (med opbukket kant, with bent up edges, mit hochgebogener Kante, avec bord plié)	62 262 00
	4.40 AF/AFK	62 273 00
	0.35 S/SN , 4.40 AF/SN-AM-DC, 4.40 A/K H 233, 4.4 K-SN, 4.40L	62 284 00
	H 192	62 352 00
	4.50, 4.55, 4.7	62 357 00
	4.60	62 275 00
Corghi	Erco 4004B	62 265 00
	Erco 4400	62 272 00
Effemme	Power Up 45 (low profile), Power Up 50 (standard)	62 298 00
ETG		62 472 00
FOG	403, 404, 490, 495, 497, 499	62 359 00
	493 Quadra	62 283 00
	493 Quadra m lys, w. lights, mit Licht, avec éclairage	62 286 00
	494 Levithan	62 265 00
	494900I	62 286 00
Hermann	Aulutrack 4,50 & 4,60	62 293 00
Hofmann	Europalift, Europa IV, Quattrolift 3500	62 359 00
	Multilift PSWT 4B *)	62 280 00
	Multilift 4000	62 343 00
	Service lift 4000, 5000, Quattrolift 4000 SL *)	62 280 00
HPA	P4C WLCT	62 465 40
Hunter	RX40	62 353 00
IME	HVS35	62 262 00
Intertech	HH 440, INT. 435I	62 359 00
	INT. 4400	62 262 00
	INT. 4352, 4402	62 263 00
	INT. 4401, 4404, 4407 , 450 N/5	62 276 00
	INT. 4600 (62.258.00 + 4x62.257.00; hvis variabel, when adjustable, fals variabel, si réglable)	62 265 00

Istobal	42721, 42722, 42724, 42725, 42727, 4 EDO-100-151-300-351-600	62 262 00	
	4 EDO 400-500	62 270 00	
John Bean	JBC WA 2,0 –WA 4,0 *)	62 280 00	
	48109B (hjul justering, wheel alignment, Rad Justierung, plaques de réalignement)	62 356 00	
Launch	TLT 440, TLT 440 W, TLT 455W	62 280 00	
Maha	DUO, DUO + I, Matop, Servicelift	62 293 00	
	Carlift II 3,5 Alu./Stahl	62 355 00	
	Carlift 4, Carlift 4, I	62 270 00	
	Carlift II 4,0	62 355 00	
	ZS Square 3.5	62 293 00	
Maic (Giuliano, Silver)	3500, 3600, 4000, 4200, 5000	62 280 00	
	3500, 3600, 4000, 4200, 5000 (med lys, with light, mit Licht, avec éclairage)	62 283 00	
Mondolfo	TITAN X 573LT	62 475 00	
	TITAN PI 441 B, PI 443B	62 265 00	
	TITAN X443 (LT)L	62 272 00	
	PI 451W	62 465 40	
Molnar	4488S, 4488W	62 269 00	
Nordlift	UC-3500	62 359 00	
	UC-4000	62 356 10	
	UC-5000	62 262 00	
Nußbaum	Combilift 4.32 H, 4.35 H, 4.40 H, 4.50 H & 4.65 H (til, until, bis, jusqu'à april 2009), 4.80 H	62 283 00	
***next page	4.65 H, 4.80 H	62 268 00	
	Unilift 3000	62 475 00	
	Unilift 3500 CLT/NT + 5000 NT, 3500NT PLUS, 5000NT, (uden lys, without light, ohne Licht, sans éclairage)	62 268 00	
	Unilift 3500, Unilift 5000	62 283 00	
	Unilift 3500 NT/CLT fra/von/from/de 04/2013, Unilift 5000 NT/CLT fra/von/from/de 04/2013	62 481 00	
	Unilift 5000 CCT PLUS QUATRO SST, QUATRO CLT 3,5 t	62 344 00	
	Unilift 4000, Unilift 3200, Unilift 3000, 4.40H (til, until, bis, jusqu'à 2001)	62 274 00	
	4.30 H	62 275 00	
	Toplift 2,32/2,35 TSA	62 341 00	
	4.40H, 4.45H, 4.45HN, 4.50H	62 346 00	
	4.40H-ND	62 346 50	
	OMA	520, 521, 522, 525, 526, 527, 527A	62 263 00
		523, 439	62 359 00
524, 524A, 527R **)		62 276 00	
528, 526 LT (JC)		62 477 00	
OMCN	399	62 359 00	
	400 (med lys, with light, mit Licht, avec éclairage)	62 263 20	
	400, 401, 401LS, 402, 402LS, 403LS	62 472 00	
	405	62 352 00	
Omer	VEGA 35, 35LT, 50, Fox 36R	62 283 00	
	VEGA 30	62 273 00	
	Viva 50	62 280 00	
	Kar 45	62 270 00	
	Stelth 40	62 355 00	
Pro-lift	MAS 0.45 LT Bridge	62 289 00	
Provac	FS40	62 353 00	
Orlandini	101, 102, 104	62 359 00	

Ravaglioli	RAV 404, 410, 421, 420 NI (med opbukket kant, with bent up edges, mit hochgebogener Kante, avec bord plié)	62 262 00
	RAV 422, 4250, 4350, 4251, 4252, 4351 (til, until, bis, jusqu' 2007)	62 270 00
	(uden kant, without bent up edges, ohne Kante, sans bord plié)	
	(4401, 4402 - nogle få førsteudgaver, for few first editions, für einige Erstausgaben, quelques undes premiers modèles)	
	RAV4401,4402,4405, 4406, 4300,4350, 4351, 4400, 4501, 4352, 4502/E (fra, since, von, depuis 2007), 4405E, Sirio SRQ 400	62 465 40
	RAV 630, 635, 640, 650, 660 m. lys, with lights, mit Licht, avec éclairage (fra, since, von, depuis 2008)	62 476 00
	RAV 630, 635, 640, 650, 660 , 630SI, 635SI, 640SI, 650SI, 660SI without lights	62 470 00
	For the 600-series there are many variations, please send photo and ask at AC	
	RAV 4506 OF	62 470 25
Rotary	SM123, SM41, SM43, SM44	62 280 00
	SM40, SM65-51/55	62 402 00
Sherpa	Safelift 4-2	62 277 00
Sice	PQC40WCT	62 465 40
	PQC 40 CT	62 476 00
Slift	Classic CS 40	62 270 00
	Maestro M-A32.386	62 355 00
Snap-on (Sun)	EELR 113A/114A **)	62 270 00
Space	SQ406	62 470 25
	SQ503	62 465 40
	SF6502	62 470 00
	SQ350, SQ351, SQ401, SQ405E, SQ400, SQ501E, SQ402, SQ406E, SQ502E	62 265 20
Stenhøj	Major, Mono (til, until, bis, jusqu' 1997) (m. opbukket kant, with bent up edges, mit hochgebogener Kante, avec bord plié)	62 262 00
	Biglift	62 264 00
	Major 400, 500, 4030, 5230, Mono (fra, since, von, depuis 1997)	62 264 10
	(med påskruet alukant (16mm), with alu edge (16 mm), mit Aluminiumschienen (16 mm), avec bord en alu (16 mm))	
	Ny konstruktion fra 2004, new construction since 2004, neuer Konstruktion seit 2004, nouvelle construction à partir de 2004)	
	(In Great Britain mounted without alu edges)	62 265 10
	Fra, since, von, depuis 2009-2012 with edge, kant, Kante, rail: Major 3351 S, 4030 , 5230, 7230	62 471 50
	Major 3351 / 4026 - 42 / 4030 – 5230, 5230-55 S og 6230 -55 S , Major 4830 ALT MOT	62 478 00
	:Lifte fra 2012 u. kant KUN anvendelig på lifte uden lys eller med LED lys monteret.	
	For lifts from 2012 without edge.Only for lifts without light or w/LED Für Bühnen von 2012 ohne Kante. Nur für Bühnen	
	ohne Licht oder mit LED. Pour ponts à partir de 2012 sans rail. Seulement pour ponts sans éclairage ou avec LED.	
	Monarch 35 (fra, since, seit, depuis 2002)	62 353 00
	- nogle få førsteudgaver, for few first editions, für einige Erstausgaben, quelques un des premiers modèles)	
	Monarch 35 (ændret fra 2004, changed since 2004, seit 2004 geändert, changé à partir de 2004 **) 5mm kant, edge, Kante, bord	62 280 00
	Monarch 35 (ændret fra 2004, changed since 2004, seit 2004 geändert, changé à partir de 2004 **) 10mm kant, edge, Kante, bord	62 270 00
	MS45 & MS50	62 298 00
Steril Koni	KO/KS 4040, KO/KS 4045, KO/KS 2028D, KO/KS 4028, KO/KS 4025, 4035	62 262 10
	ST 0035D, ST 4032, 4040, 4055, 4070 F/V/LV (evt. 62.270.00)	62 353 00
	4032F	62 353 00
	ST4040WA	62 354 60
Tecalemit	SF8788 (4 ton)	62 273 00
	SF9650, SF 9657	62 265 00
TEXO	Xenia 3 ton, 4 ton, 5 ton (ændringer 2004, changes 2004, Änderungen 2004, modifié 2004)	62 290 00
	Fulgor PSWT 4 (ændringer 2004, changes 2004, Änderungen 2004, modifié 2004)	62 280 00
Tip Top	Prolift 4.40 AS/A	62 284 00
Union	8702, 8704, 8705	62 262 00
Velyen	4 ED 1000R	62 355 00
Werther (EWJ)	W437, W439, W440	62 359 00
	W443, W442LP, WATLT443 , W450 3D	62 276 00
	W430, W435, W436, W441, W442, W450	62 263 00
	W450 m. lys, with lights, mit Licht, avec éclairage	62 270 00
	W460, W450LT, W450ATLT (+62.258.00 ; hvis variabel, when adjustable, fals variabel, si réglable)	62 265 00

Zippo	2305, 2306, 2405	62 283 00
	2420	62 275 00
	9340Z	62 270 00
	8090, 8091, 8191, 8450 st	62 289 10
	4149.I***, 4149.I AV***, 4149.I RF***, 4149.I RFAV***, 4149.I ASD***, 4149.I RFASD***	62 290 00
	4144, 4149 - Justerbar kørebaner, adjustable platforms, Verschiebbare fahrschienen, rails de roulement réglable	62 284 00
	8135, 8140	62 280 00

DK

Denne liste er baseret på enkelte eksemplarer af de pågældende lifte. AC tager forbehold for eventuelle ændringer i liftproducenternes produkter. Erfaringer med kombineret af lifte og ophæng modtages gerne.

- *) Kontroller afstand mellem ophængsskinner (min. 817 mm)
- **) Kontroller afstand mellem ophængsskinner (min. 830 mm)
Hvis afstanden mellem ophængsskinnerne er mindre end 830 mm og mere end 785 mm, anbefales ophæng 62.290.00.
- ***) Kun brugbar uden lys.
- ****) På grund af hyppige ændringer på serien af Nussbaum lifte kan vi ikke garantere, at de angivne ophæng passer. Derfor venligst kontakt os eller medsend målskema til lift ved bestilling!

D

Diese Liste ist auf einzelne Exemplare der betreffenden Hebebühne basiert, darum nimmt AC den Vorbehalt, daß die Produkte eventuell vom Produzenten geändert werden können. Wir würden Sie freundlichst bitten, uns Ihre Erfahrungen mit der Kombination Lift / Aufhängungen weiterzugeben.

- *) Bitte den Abstand zwischen den Fahrschienen kontrollieren (min. 817mm)
- **) Bitte den Abstand zwischen den Fahrschienen kontrollieren (min. 830mm).
Bei einem Abstand zwischen den Fahrschienen kleiner als 830 mm und größer als 785 mm empfehlen wir Aufhängung 62.290.00.
- ***) Hebebühnen ohne Licht
- ****) Aufgrund einiger Änderungen innerhalb der Serie bei Nussbaum Bühnen können wir nicht für die Richtigkeit garantieren und bitten daher uns zu kontaktieren oder eine Zeichnung auszuhändigen!

GB

This list is based upon a few examples of the lift in question and is only valid provided the lift manufacturers do not make any changes. Please inform us, if you have any experience with different combinations of lifts and support arms.

- *) Please check distance between support rails (min. 817 mm)
- **) Please check distance between support rails (min. 830 mm).
If the distance between the support rails is less than 830 mm and more than 785 mm we would recommend support arms 62.290.00.
- ***) Only useable without lights.
- ****) As a consequence of the frequent changes in the Nussbaum lift series we are not able to guarantee that the suggested support arms fit. Please contact us or forward the specification form for lifts when ordering!

F

Cette liste est élaborée sur la base de quelques exemplaires de ponts et la liste est seulement valable sous réserves que le fabricant n'a pas fait de modifications. Veuillez nous faire savoir plus sur vos expériences avec différentes combinaisons de ponts et de jeux d'accroches.

- *) Veuillez contrôler la distance entre les rails de roulement (min. 817 mm)
- **) Veuillez contrôler la distance entre les rails de roulement (min. 830 mm). Si la distance entre les rails est moins de 830 mm et plus de 785 mm nous recommandons le jeu d'accroche 62.290.00.
- ***) Only useable without lights.
- ****) En raison des modifications fréquentes sur les séries de pont Nussbaum nous ne sommes pas en mesure de garantir que les jeux de supports sont les bonnes. Veuillez nous contacter ou nous faire parvenir le plan de mesure pour pont avec votre commande!

62 262 00

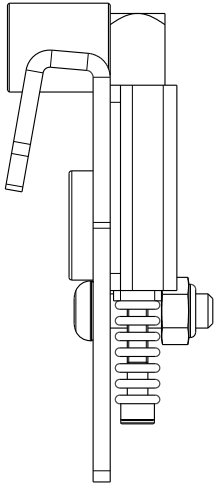

62 262 10

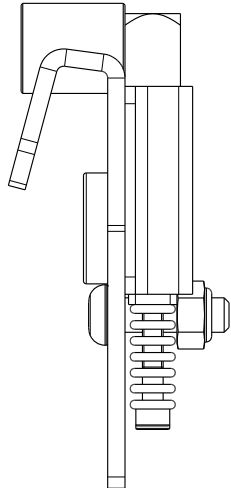

62 263 00

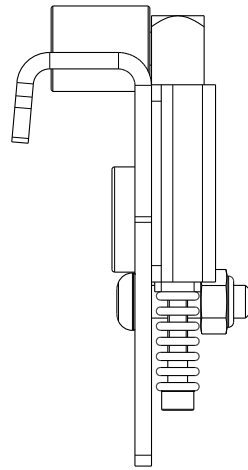

62 263 20

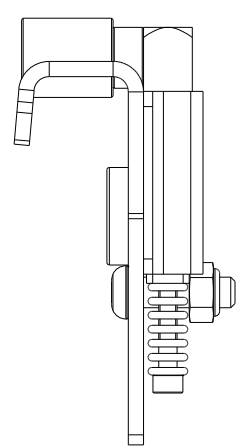

62 264 00

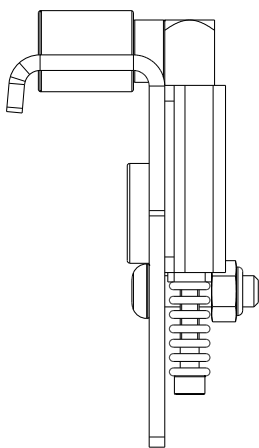

62 264 10

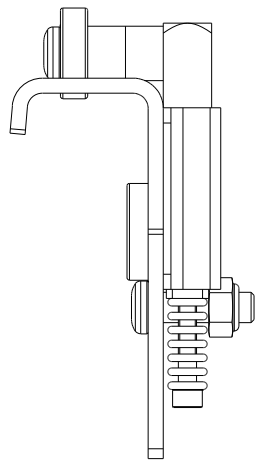

62 265 00

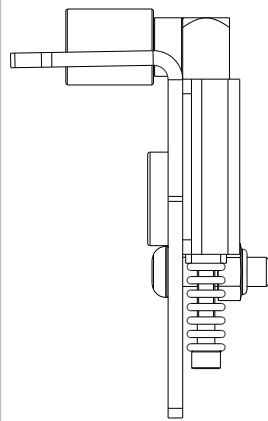

62 265 10

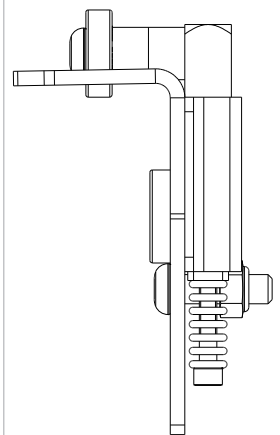

62 265 20

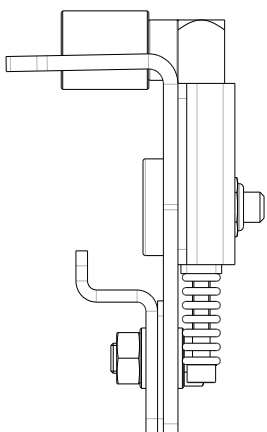

62 267 00

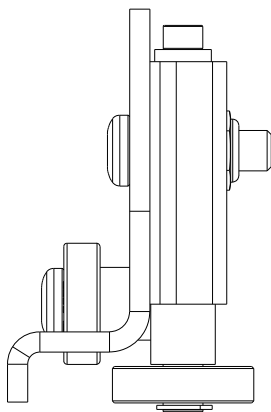

62 268 00



62 269 00

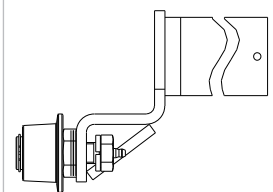

62 270 00

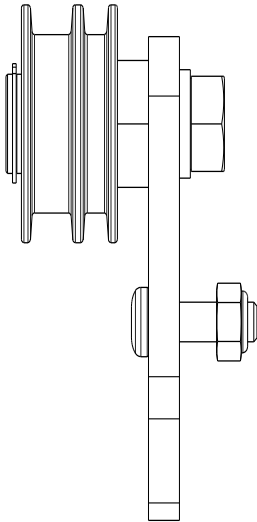

62 272 00

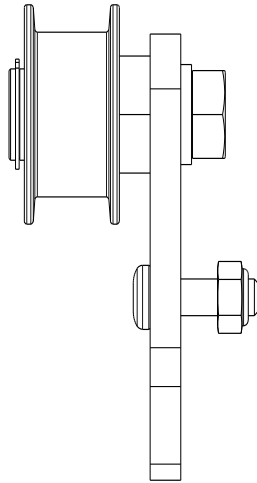

62 273 00

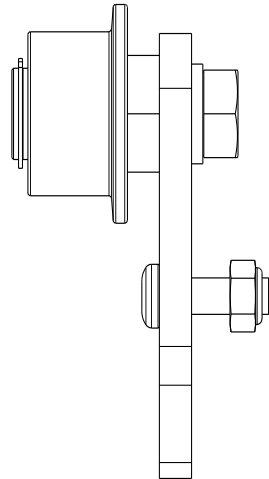

62 274 00

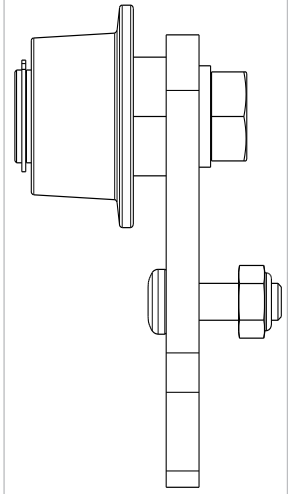

62 275 00

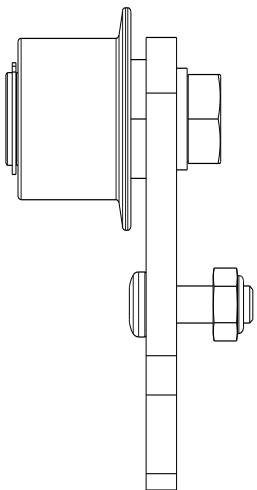

62 276 00

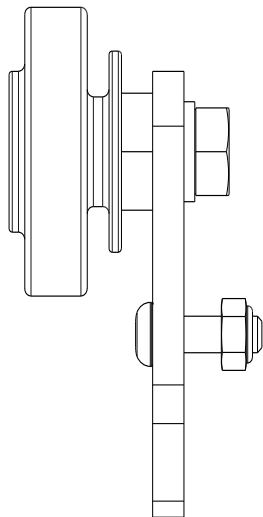

62 277 00

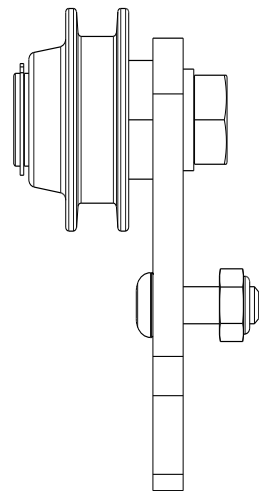

62 280 00

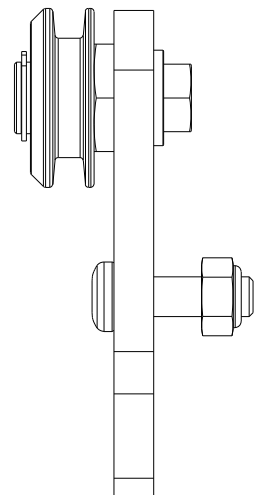

62 281 00

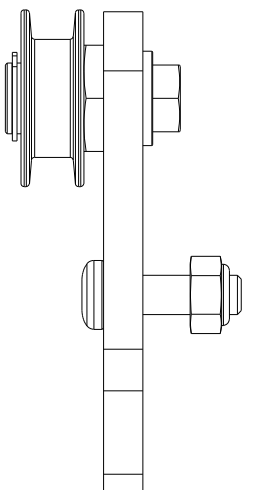

62 282 00

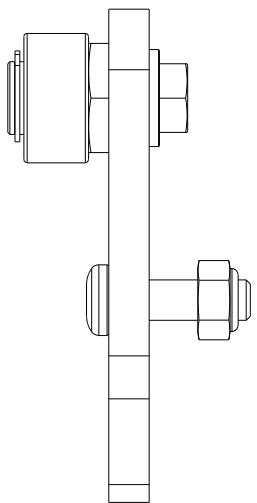

62 283 00

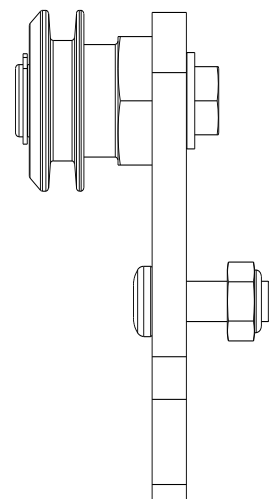

62 284 00

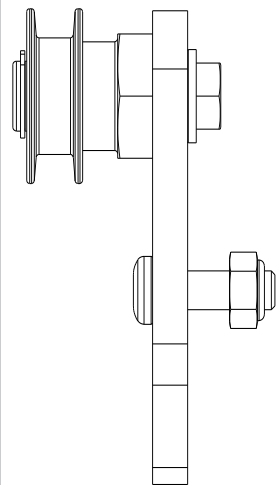

62 285 00

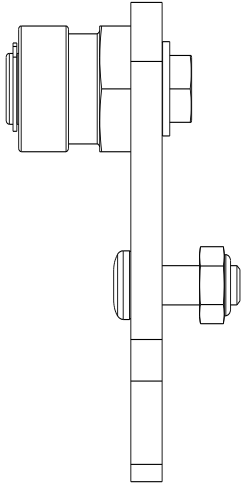

62 286 00

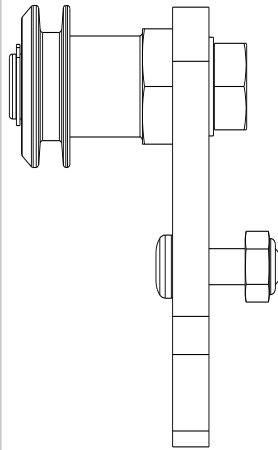

62 287 00

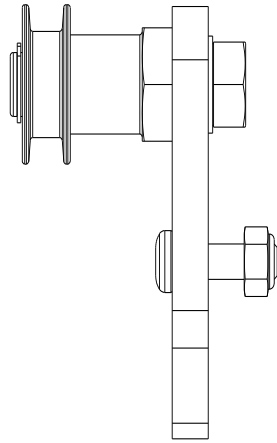

62 288 00

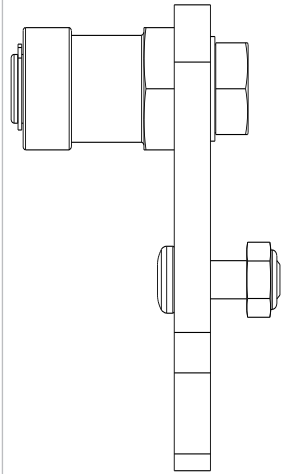

62 289 00

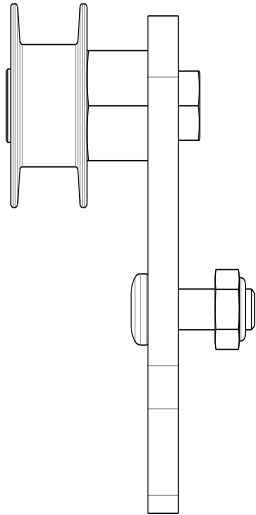

62 289 10

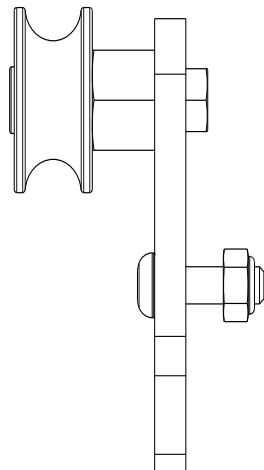

62 290 00

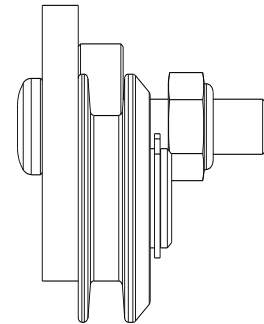

62 292 00

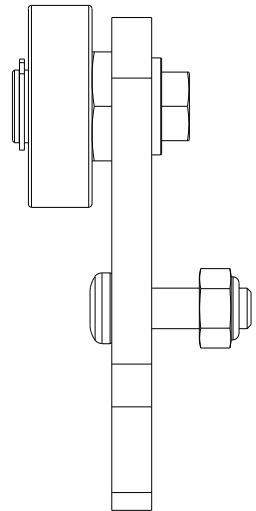

62 293 00

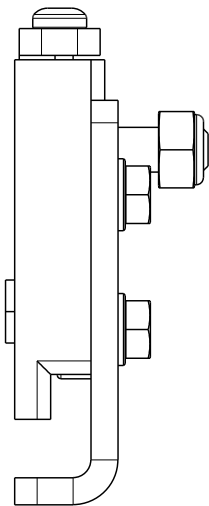

62 295 00

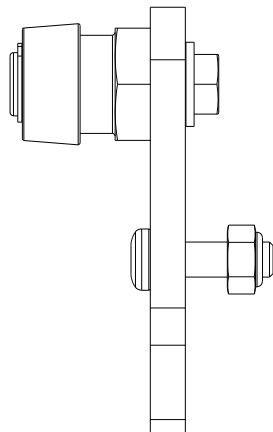

62 298 00

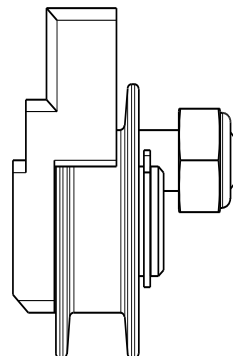

62 341 00

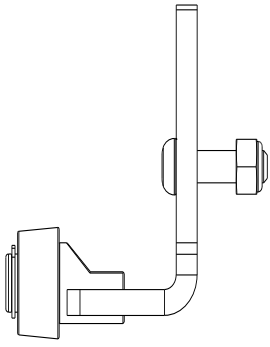

62 342 00

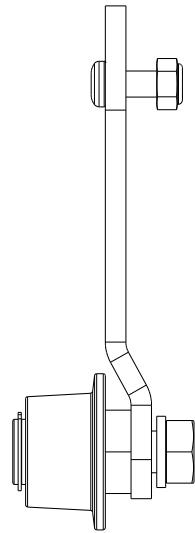

62 343 00



62 344 00

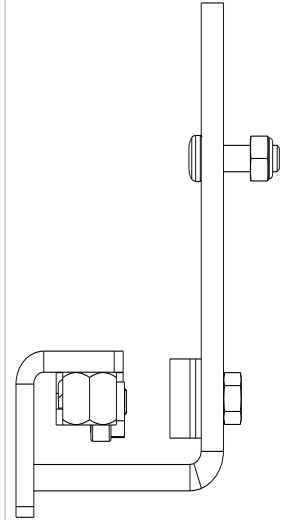

62 346 00

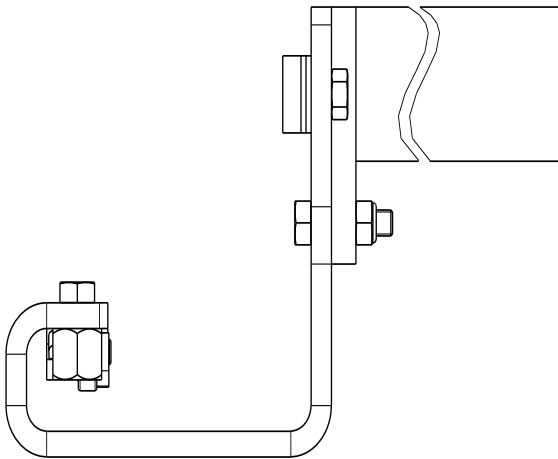

62 346 50

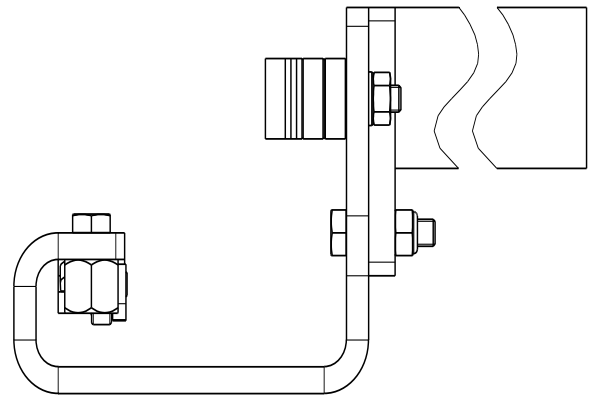

62 352 00

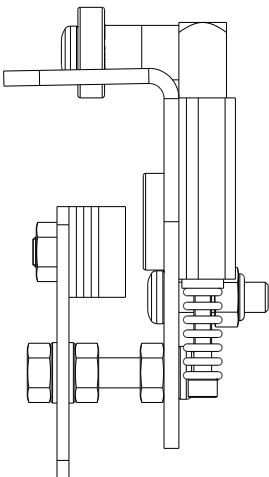

62 353 00

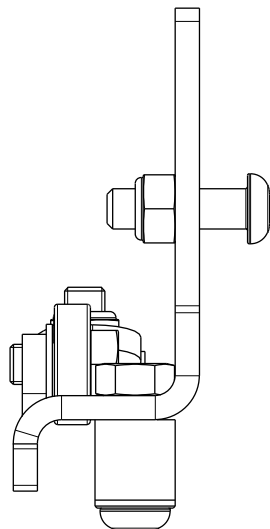

62 354 00

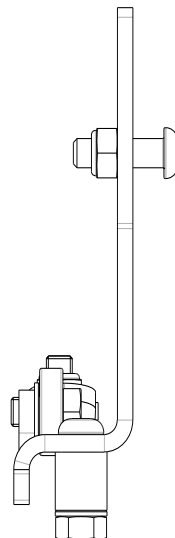

62 354 60

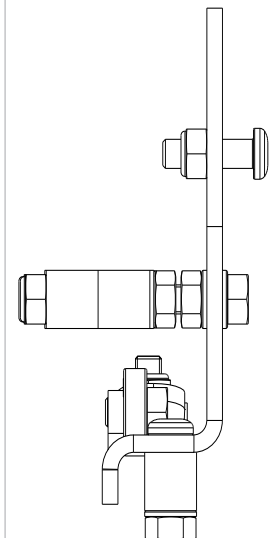

62 355 00

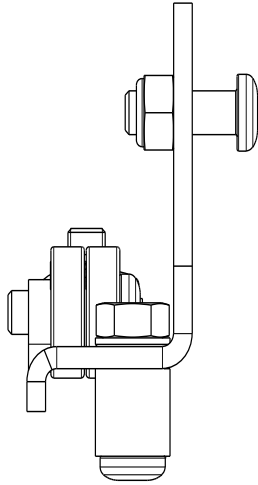

62 356 00

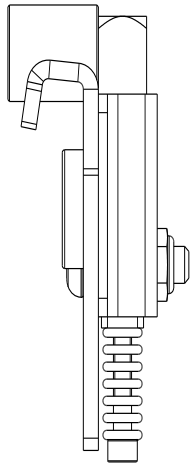

62 356 10

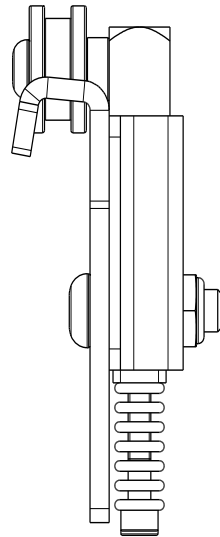

62 357 00

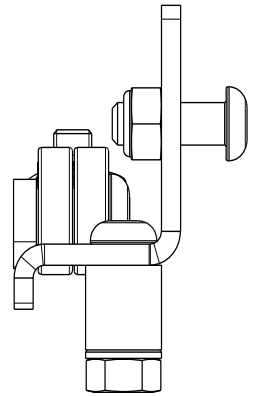

62 358 00

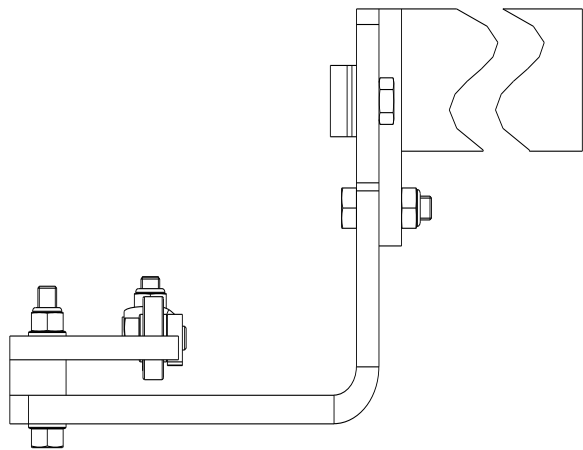

62 359 00

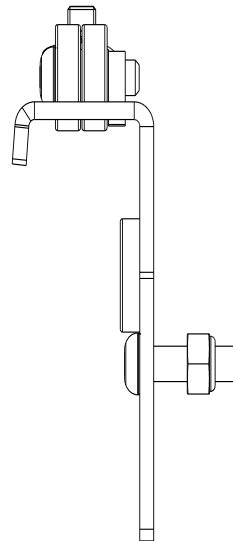

62 359 20

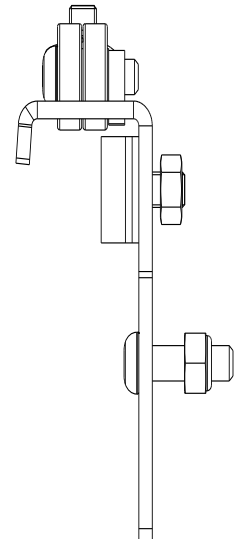

62 402 00

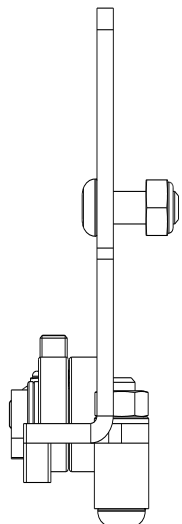

62 465 40

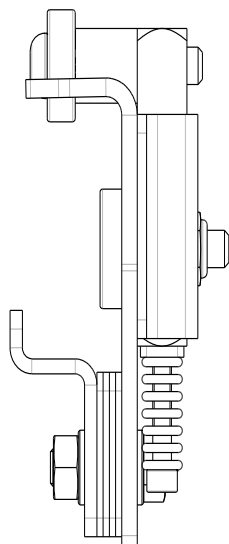

62 470 00

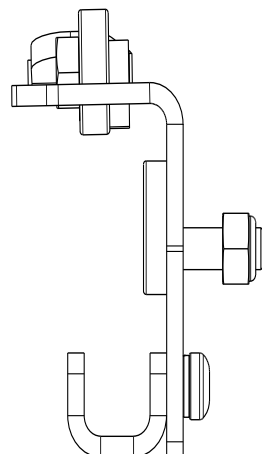

62 470 25

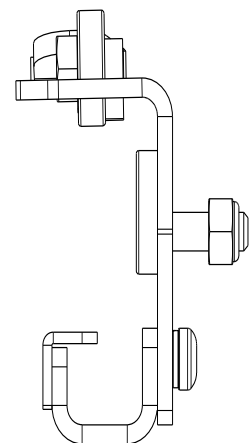

62 471 50

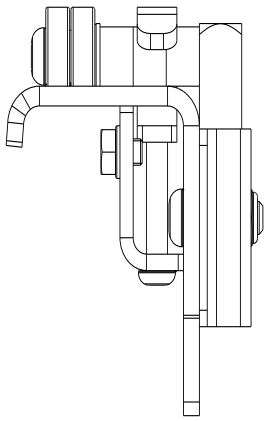

62 472 00

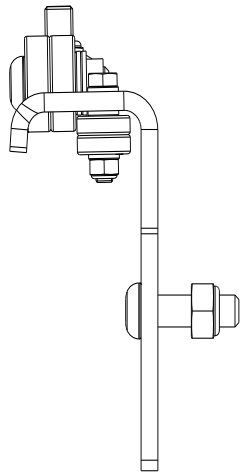

62 475 00

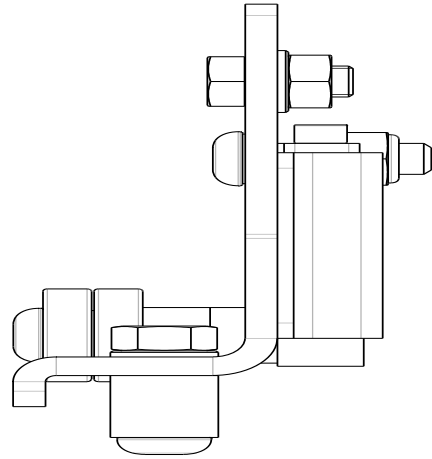

62 476 00

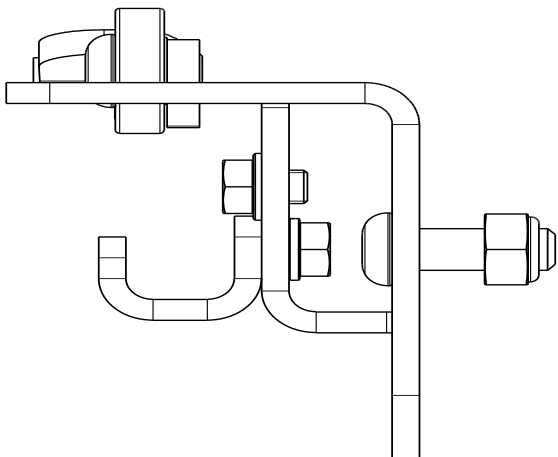

62 477 00

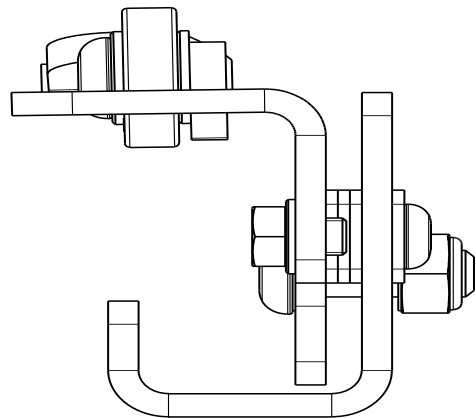

62 478 00

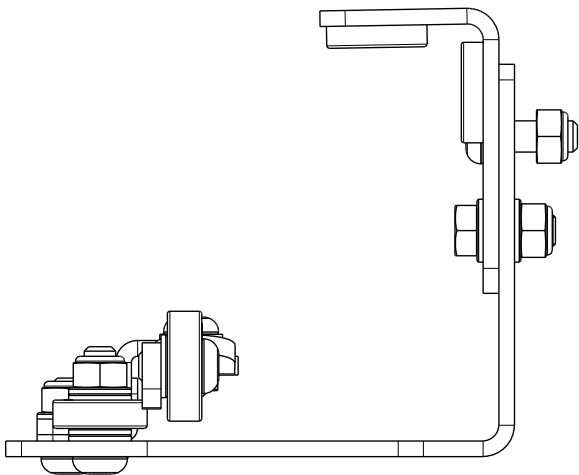

62 481 00

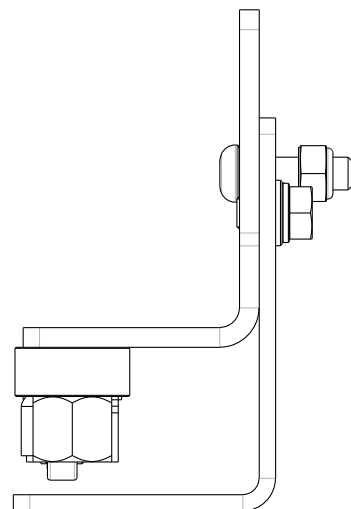

62 482 00

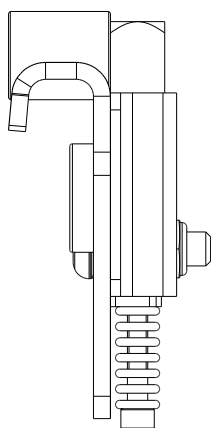

Varenr. Article no. Artikel Nr. Référence	A	B	C	D	E	L		H		W							
						min.	max.	min.	max.	min.	max.						
						62 262 00	-	12	-	ø25	-	125	187,5	-2,5	65	805	1205
						62 262 10	-	12	-	ø25	-	125	187,5	-2,5	65	805	1205
62 263 00	-	28	-	ø25	-	125	187,5	-2,5	65	805	1205						
62 263 20	-	28	-	ø25	-	125	187,5	-2,5	65	805	1205						
62 264 00	-	38	-	ø25	-	125	187,5	-2,5	65	805	1205						
62 264 10	-	38	-	ø30	-	125	187,5	-2,5	65	805	1205						
62 265 00	-	-	(50)	ø25	-	125	187,5	-2,5	65	805	1205						
62 265 10	-	-	(50)	ø30	-	125	187,5	-2,5	65	805	1205						
62 265 20	-	-	(50)	ø25	-	131	143	44	56	805	1205						
62 267 00	-	(20)	-	ø30	-	36	73	114	151	800	1200						
62 268 00	(29)	(16)	(25)	ø32	32	-28	34	152	214	886	1286						
62 269 00	(79-75)	26	33,5	ø45	ø52,5	-17,5	22,5	167,5	207,5	946	1346						
62 270 00	14,5	7/12,5	33,5	ø45	52,5	-2,5	150	40	192,5	830	1230						
62 272 00	14,5	24	33,5	ø45	52,5	-2,5	150	40	192,5	830	1230						
62 273 00	14,5	26	31,6	ø45	52,5	-2,5	150	40	192,5	830	1230						
62 274 00	14,5	26	31,8	ø45	52,5	-2,5	150	40	192,5	830	1230						
62 275 00	5	33	38,3	ø43,5	52,5	-2,5	150	40	192,5	820	1220						
62 276 00	14	-	32	ø79	-	24,5	127,5	58,5	210,5	828	1228						
62 277 00	12	12,5	34	ø45	52,5	36	73	114	151	824	1224						
62 280 00	8	7	17	ø30	37,5	5	157,5	32,5	185	817	1217						
62 281 00	8	10,5	17	ø30	37,5	5	157,5	32,5	185	817	1217						
62 282 00	(6)	(16)	(20)	ø30	30	5	157,5	32,5	185	812	1212						
62 283 00	23	7	17	ø30	37,5	5	157,5	32,5	185	847	1247						
62 284 00	23	10,5	17	ø30	37,5	5	157,5	32,5	185	847	1247						
62 285 00	(20)	(16)	(20)	ø30	30	5	157,5	32,5	185	840	1240						
62 286 00	37	7	17	ø30	37,5	5	157,5	32,5	185	875	1275						
62 287 00	37	10,5	17	ø30	37,5	5	157,5	32,5	185	875	1275						
62 288 00	(34)	(16)	(20)	ø30	30	5	157,5	32,5	185	870	1270						

Varenr. Article no. Artikel Nr. Référence	A	B	C	D	E	L		H		W							
						min.	max.	min.	max.	min.	max.						
						62 289 00	23	19	23,5	ø30	40	-1,5	150,5	34	186	846	1246
						62 289 10	23,5	18	23	ø32	41		151	35	187	847	1247
62 290 00	(-11)	7	(17)	ø30	37,5	60	72,5	117,5	130	780	1130						
62 292 00	(5)	(16)	(20)	ø50	50	-5	147,5	42,5	195	812	1212						
62 293 00	0	9	17	(ø30)	80,5	28,5	65,5	114	151	786	1186						
62 295 00	(20)	(16)	(20)	ø32	32	2	156	31	186	840	1240						
62 298 00	-	10,5	22	ø30	37,5	60	72	114	126	785	1176						
62 341 00	(45)	(16)	(21)	ø35	35	-7	30,5	159,5	197	886	1286						
62 342 00	5,5	26	33,5	ø45	52,5	-73,5	-41	231	263,5	808	1208						
62 343 00	(-16,5)	7	18,5	ø30	37,5	-75,5	-43	233	265,5	764	1164						
62 344 00	45	9	38	ø30	-	-22	-40	165	227	890	1290						
62 346 00	110,5	9	-	ø30	37	-25	25	161	211	1078	1378						
62 346 50	110,5	9	-	ø30	37	-8	154	17	179	1069	1369						
62 352 00	-	-	(50)	ø30	-	125	187,5	-2,5	65	805	1205						
62 353 00	(30-20)	4-14	20-10	ø30	33	8	70,5	116	178,5	832	1232						
62 354 00	(30-20)	4-14	20-10	ø30	33	-42	19	166	228	833	1233						
62 354 60	(30-20)	4-14	20-10	ø30	33	-42	19	166	228	833	1233						
62 355 00	(31-21)	3-13	19-9	ø30	32	28	75,5	111	158,5	832	1232						
62 356 00	-	12	-	ø25	-	105	167	17,5	85	805	1205						
62 356 10	-	7	-	ø24	-	111	173	14	76	805	1205						
62 357 00	36-26	4-14	20-10	ø30	32	52	64	122	135	830	1230						
62 358 00	-	-	-	ø35	-	16,5	33,5	163	213	1050	1350						
62 359 00	-	38	-	ø30	-	129	191	-5	57	802	1202						
62 402 00	1-13,5	3,5-16	31,3-18,8	ø35	35	-11	51	136	198	794	1194						
62 359 20	-	38	-	ø30	-	129	191	-5	57	810	1210						
62 465 40	-	-	(24)	ø30	-	126	138	48	60	805	1205						
62 470 00	-	-	(40)	ø30	-	120	157	29	66	805	1205						
62 470 25	-	-	(40)	ø30	-	120	157	29	66	805	1205						
62 471 50	31,5	26	36	ø30	-	120	157	30	67	855	1255						
62 472 00	23-37	3,5-17,5	10-24		33	122,5	184,5	1,5	63,5	838	1238-1266						
62 475 00	25-33	4-12	13,5-21,5	ø30	24	15	47	134	196	842	1242						
62 476 00	-	-	(40)	ø30	-	121	158	29	66	854	1254						
62 477 00	-	-	(40)	ø30	-	120	132	55	67	805	1205						
62 478 00	-		(45)		(12)	114	151	36	73	814	1204						
62 481 00	33,5		(35)	ø30	(41)	-27	35	152	214	859	1259						
62 482 00		12(19)		ø25		111	173	14	76	805	1205						

Ophæng for saksedonkrafte
Support arms for jacking beams
Aufhängungen für Scherenheber
Jeux d'accroches pour traverses de levage

Se dimensioner på forrige side
See diagram for dimensions on previous page
Maße sehen Sie bitte auf der Vorliegen Seite
Voir dimensions sur la page précédente

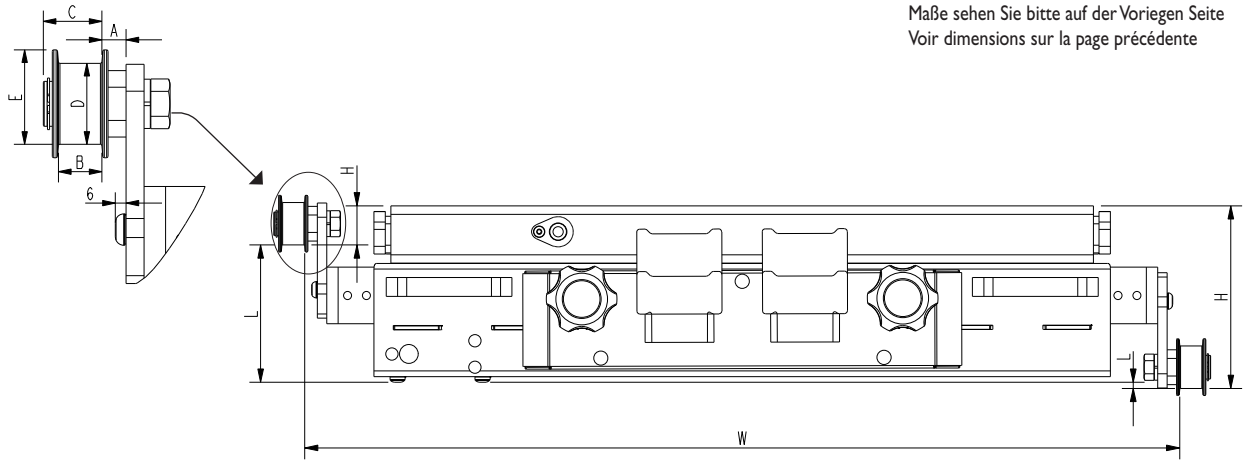

SD20/26L & SD20/26PHL

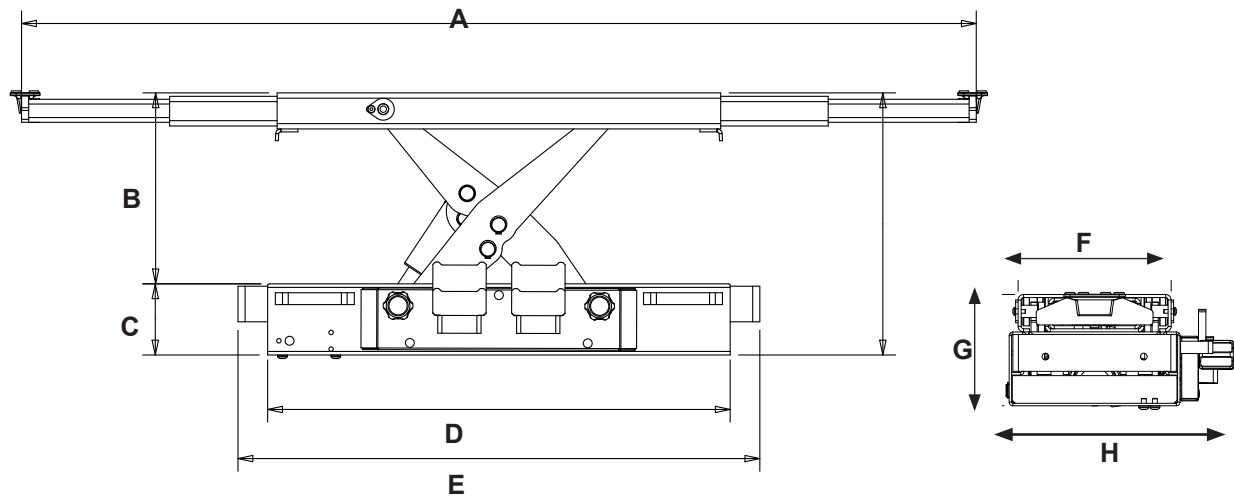

Model	A	B	C	D	E	F	G	H
SD20L	780-1610	250	120	780	780-1180	249	180	365
SD26L	780-1610	250	120	780	780-1180	249	180	365
SD20PHL	780-1610	250	120	780	780-1180	249	180	365
SD26PHL	780-1610	250	120	780	780-1180	249	180	365

A	Teleskopudtræk/Løftearme mm Telescopic arms mm. Teleskopauszug/Hubarme mm Bras télescopique mm	C	Rammehøjde mm Frameheight mm Chassishöhe mmm Hauteur de cadre mm	E	Bredde incl. udtræk mm Frame width mm Auszug Aufhängung mm Longeur de bras rallonge mm	G	Min. højde mm Min. height mm Min. Höhe mm Hauteur mini mm
B	Slaglængde mm Stroke mm Kolbenhub mm Course mm	D	Rammebredde mm Framewidth mm Rahmenbreite mm Longeur de cadre mm	F	Løfteramme bredde mm Lifting frame width mm Hubrahmen Breite mm Largeur de cadre de levage mm	H	Total bredde mm Total width mm Gesamtbreite mm Largeur totale mm

MÅLSKEMA LIFT

FL - Frihjulsløfter 6 t 12 t 16 t 20 t

SD - Saksedonkraft 2 t 2,6 t 3,2 t 4 t

Lifffabrikant: _____ Model: _____ Kapacitet: _____ Årgang: _____

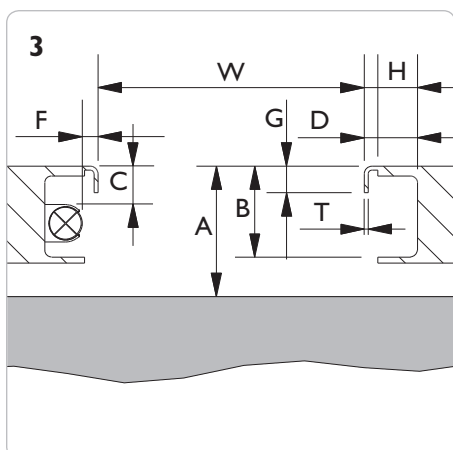
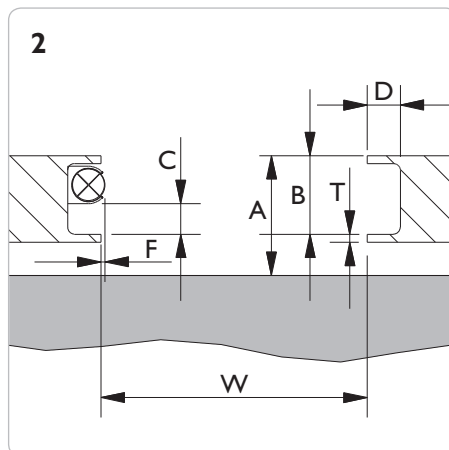
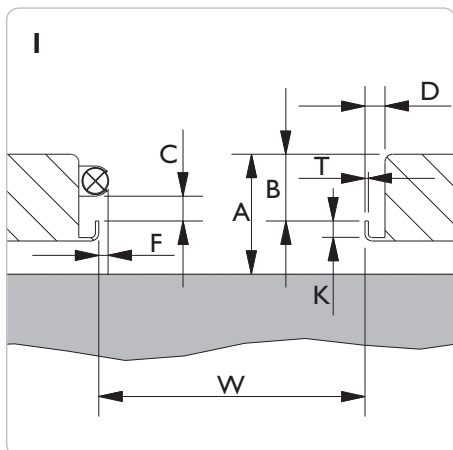

4 Skitse

Skitse nr.: _____

W = _____ mm

A = _____ mm

B = _____ mm

D = _____ mm

G = _____ mm

H = _____ mm

K = _____ mm

T = _____ mm

Hvis liften er forsynet med belysning  eller andre fremspring udfyldes mål C og F:

C min. = _____ mm

F max. = _____ mm

Skinneprofil

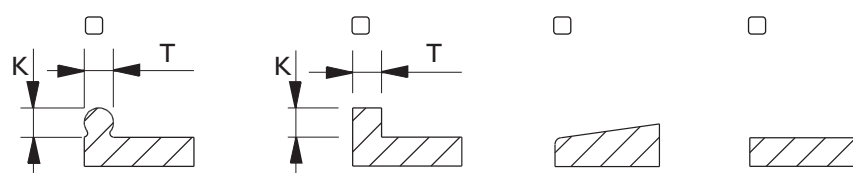

NB: Det er købers risiko/ansvar at opgive data er korrekte og fyldestgørende. Liften skal altid være konstrueret og godkendt for montering af hjælpedonkraft. **Jf. EN1493:1998 må hjælpedonkraftens kapacitet ikke overskride 0,66 x liftens kapacitet.** (En 2 tons donkraft på en 3 tons lift er ok - men ikke en 2,6 tons).

Dato: _____

Opmålt af: _____

Forhandler: _____

Underskrift: _____

MÅLSKEMA GRAV

- | | | | |
|---------------------------------------|---|-----------------------------|---|
| GD - Gravdonkraft | <input type="checkbox"/> 10 t <input type="checkbox"/> 15 t <input type="checkbox"/> 20 t | FL - Frihjulsløfter | <input type="checkbox"/> 6 t <input type="checkbox"/> 12 t <input type="checkbox"/> 16 t <input type="checkbox"/> 20 t |
| GDT - Teleskopisk gravdonkraft | <input type="checkbox"/> 15 t | SD - Saksedonkraft | <input type="checkbox"/> 2 t <input type="checkbox"/> 2,6 t <input type="checkbox"/> 3,2 t <input type="checkbox"/> 4 t |
| GGD - Gulvgravdonkraft | <input type="checkbox"/> 15 t | ABT - Aflastningsbro | <input type="checkbox"/> 20 t |
| AB - Aflastningsbro | <input type="checkbox"/> 20 t | | |

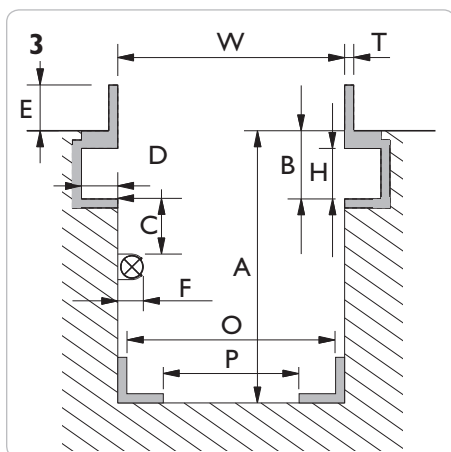
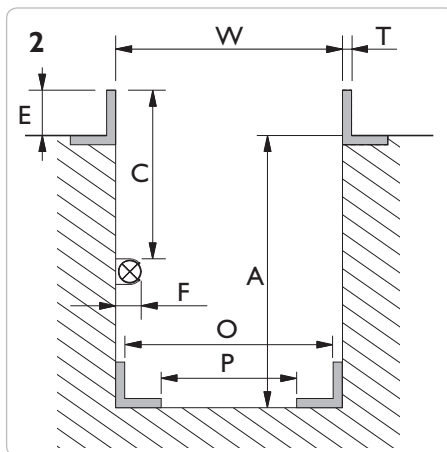
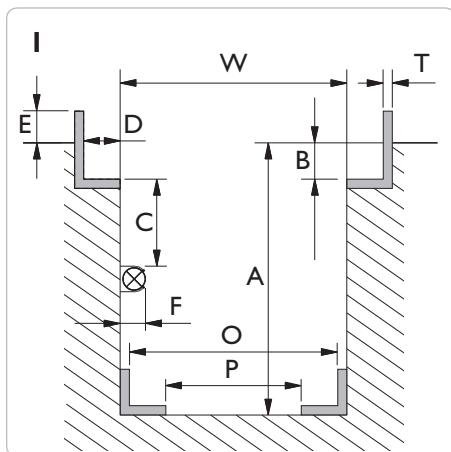

4 Skitse

Skitse nr.: _____

Mål venligst omhyggeligt flere steder i graven. **NB: Max 12 mm variation mellem W min. og W max. i hele gravens længde.**

W min. = _____ mm

W max. = _____ mm

A min. = _____ mm

B = _____ mm

D = _____ mm

E = _____ mm

H = _____ mm

T = _____ mm

Hvis graven er forsynet med belysning  eller andre fremspring udfyldes mål C og F:

C min. = _____ mm

F max. = _____ mm

GGDI50S - Gulvgravdonkraft:

O min. = _____ mm

O max. = _____ mm

P min. = _____ mm

P max. = _____ mm

Højde i forhold til gulv

Løftesadlens overkant **uden** tilbehør (travers, støttebuk eller forlænger) ønskes:

over værkstedsgulv _____ mm

i niveau med værkstedsgulv

under værkstedsgulv _____ mm

Sadlen placeres +/- 50 mm ift. ønsket niveau

Tilbehør

Bemærk at evt. montering af travers eller støttebuk forøger min. højde:

Travers T4-1 = + 100 mm

Travers T5-1 = + 95 mm

Travers T6-1 = + 55 mm

Travers T4-2 = + 145 mm

Travers T5-2 = + 140 mm

Travers T6-2 = + 90 mm

S200 = + 65 mm

Rulletype / Skinneprofil

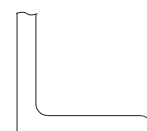
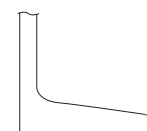

Konisk/skrå Cylindrisk/plan

NB: Det er købers risiko/ansvar at opgive data er korrekte og fyldestgørende, samt at graven er konstrueret og tilstrækkeligt forankret til den ønskede kapacitet.

Dato:

Opmålt af:

Forhandler:

Underskrift:

LIFT SPECIFICATION FORM

FL - Heavy duty jacking beam 6 t 12 t 16 t 20 t **SD** - Jacking beam 2 t 2,6 t 3,2 t 4 t

Lift: _____ **Model:** _____ **Capacity:** _____ **Year:** _____

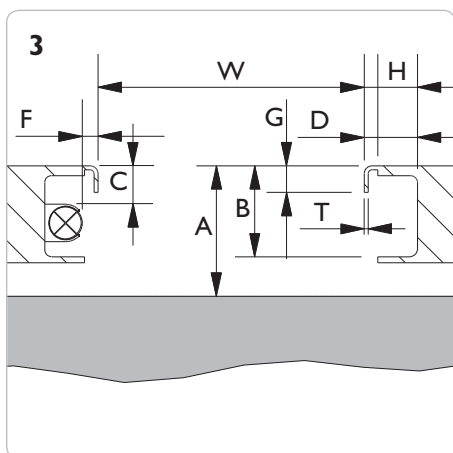
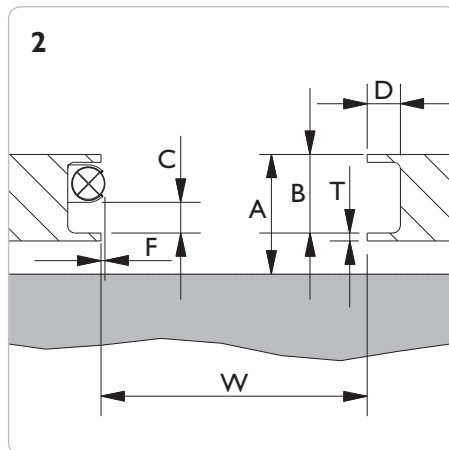
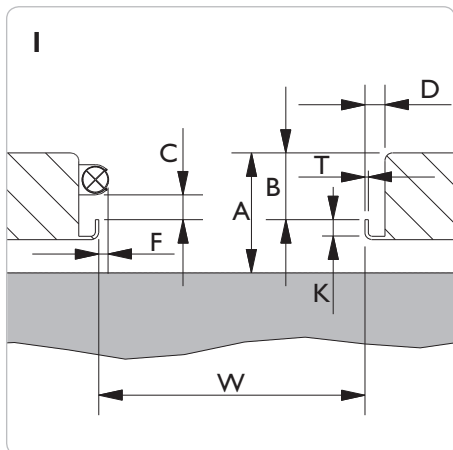

4 Drawing

Drawing no.: _____

W = _____ mm
 A = _____ mm
 B = _____ mm
 D = _____ mm
 G = _____ mm
 H = _____ mm
 K = _____ mm
 T = _____ mm

If the lift is mounted with light  or other obstructing parts, please fill out C and F:

C min. = _____ mm
 F max. = _____ mm

Rail profile

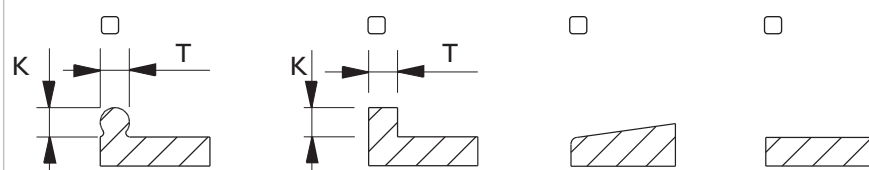

PLEASE NOTE: It is the customer's responsibility that the given measures are correct and sufficient.
N.b. EN1493:1998 the capacity of the jacking beam cannot exceed 0,66 x the capacity of the lift.
 (A 2 t jacking beam on a 3 t lift is okay - but not a 2,6 t).

Date: _____ **Measured by:** _____ **Dealer:** _____ **Signature:** _____



PIT SPECIFICATION FORM

- GD** - Pit jack 10 t 15 t 20 t
- GDT** - Telescopic pit jack 15 t
- GGD** - Floor pit jack 15 t
- AB** - Support bridge 20 t

- FL** - Heavy duty jacking beam 6 t 12 t 16 t 20 t
- SD** - Jacking beam 2 t 2,6 t 3,2 t 4 t
- ABT** - Support bridge 20 t

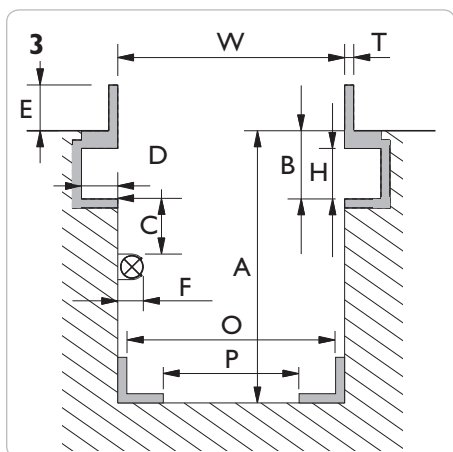
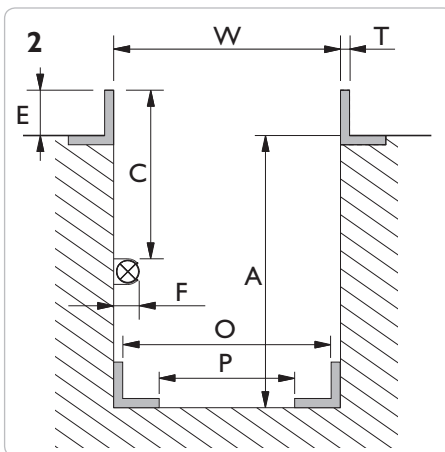
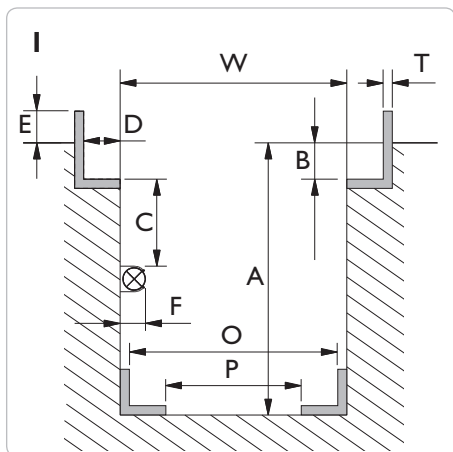

4 Drawing

Drawing no.: _____

Please measure various places along the length of the pit. **Max 12 mm variation between W min og W max. throughout the pit length**

W min. = _____ mm

W max. = _____ mm

A min. = _____ mm

B = _____ mm

D = _____ mm

E = _____ mm

H = _____ mm

T = _____ mm

If the pit is mounted with light or other obstructing parts, please fill out C and F:

C min. = _____ mm

F max. = _____ mm

GGDI50S - Floor pit jack

O min. = _____ mm

O max. = _____ mm

P min. = _____ mm

P max. = _____ mm

Placing of saddle

The placing of top saddle **excluding** cross beam adaptor, safety stand and extensions is required:

- above workshop floor _____ mm
- levelling with workshop floor
- below workshop floor _____ mm

The top of the cylinder will be positioned +/- 50 mm according to requested level

Option

Please note, mounting of different options will increase the min. height:

- Cross beam T4-1 = + 100 mm
- Cross beam T5-1 = + 95 mm
- Cross beam T6-1 = + 55 mm
- Cross beam T4-2 = + 145 mm
- Cross beam T5-2 = + 140 mm
- Cross beam T6-2 = + 90 mm
- Safety stand S200 = + 65 mm

Rolltype / Rail profile

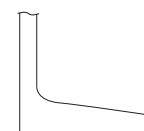

Conical/
tilted

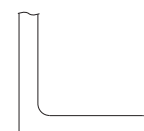

Cylindrical/
straight

PLEASE NOTE: It is the customer's responsibility that the given measures are correct and sufficient and that the pit is built and anchored to withstand the designated loading.

Date:

Measured by:

Dealer:

Signature:

MAßBLATT HEWEBÜHNE

FL - Achsfreiheber 6 t 12 t 16 t 20 t

SD - Scherenheber 2 t 2,6 t 3,2 t 4 t

Hebebühne: _____ Modell: _____ Kapazität: _____ Baujahr: _____

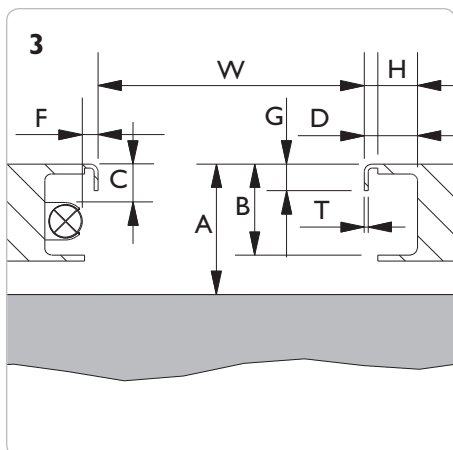
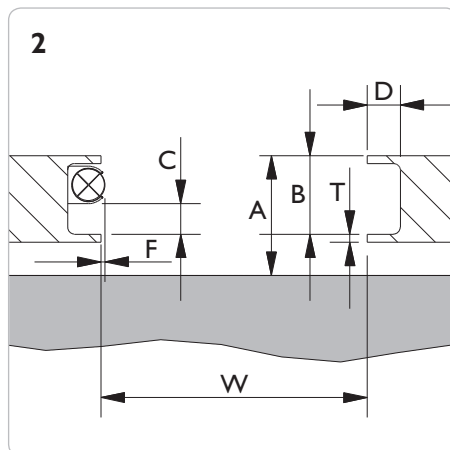
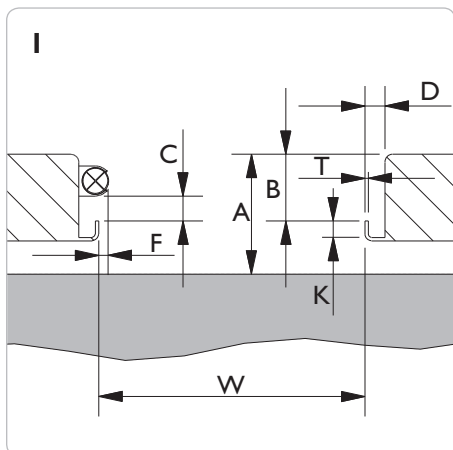

4 Skizze

Skizze Nr.: _____

- W = _____ mm
- A = _____ mm
- B = _____ mm
- D = _____ mm
- G = _____ mm
- H = _____ mm
- K = _____ mm
- T = _____ mm

Falls die Bühne mit Licht  oder andere Hindernisse ausgestattet ist, bitte C und F ausfüllen:

- C min. = _____ mm
- F max. = _____ mm

Befestigung (bitte markieren)

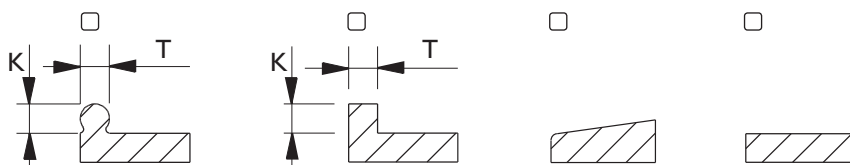

Der Käufer trägt die volle Verantwortung für eine korrekte Bemaßung. Die Hebebühne muss für die Montage eines Heber immer konstruiert und genehmigt sein. **Vgl. ENI 493:1998, Kapazität des Hebers darf 0,66 x Kapazität der Hebebühne nicht überschreiten.** (ein 2 t Heber ist ok auf einer 3 t Hebebühne ist ok - aber nicht ein 2,6 t).

Datum: _____

Maßangaben von: _____

Händler: _____

Unterschrift: _____

MAßBLATT GRUBE

- GD** - Grubenheber 10 t 15 t 20 t
GDT - Teleskopischer Grubenheber 15 t
GGD - Bodenlauf. Grubenheber 15 t
AB - Abstützbrücke 20 t

- FL** - Achsfreiheber 6 t 12 t 16 t 20 t
SD - Scherenheber 2 t 2,6 t 3,2 t 4 t
ABT - Abstützbrücke 20 t

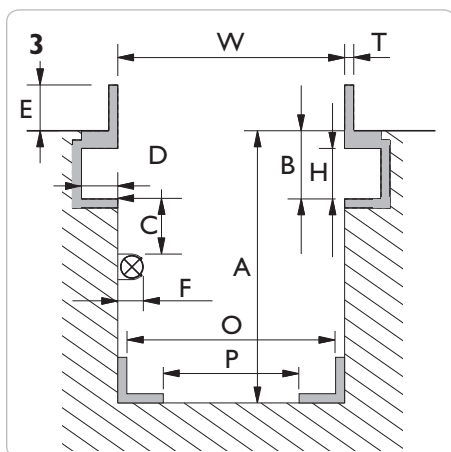
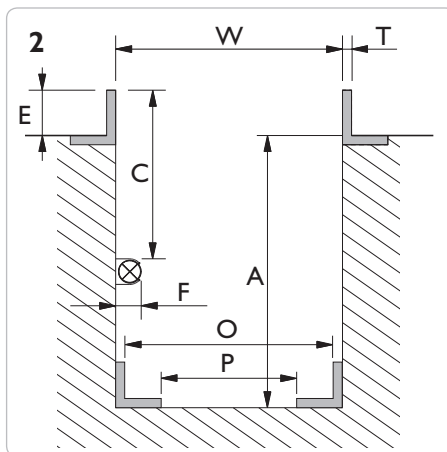
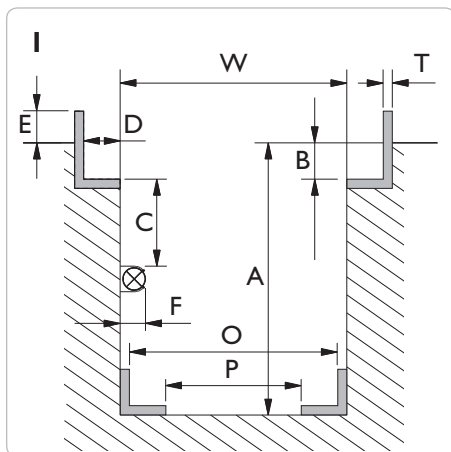

4 Skizze

Skizze Nr.: _____

Messen Sie sorgfältig an verschiedenen Stellen der Grube. **Bitte beachten Sie: W min. und W max. darf max. 12 mm variieren**

W min. = _____ mm

W max. = _____ mm

A min. = _____ mm

B = _____ mm

D = _____ mm

E = _____ mm

H = _____ mm

T = _____ mm

Falls die Bühne mit Licht \otimes oder anderen Hindernissen ausgestattet ist, bitte C und F ausfüllen:

C min. = _____ mm

F max. = _____ mm

GGDI50S - Grubenheber

O min. = _____ mm

O max. = _____ mm

P min. = _____ mm

P max. = _____ mm

Plazierung des Hubsattels

Die Oberkante des Hubsattels **ohne** Zubehör (Traverse, Sicherheitsgestell oder Verlängerung):

- über Werkstattboden _____ mm
 niveaugleich mit Werkstattboden
 unter Werkstattboden _____ mm

Die Höhe des Sattels wird um +/- 50 mm gemäß Ihrem Wunsch positioniert

Zubehör

Bitte beachten Sie, daß eine eventuelle Montierung von Traverse oder Sicherheitsgestell die min. Höhe erhöht:

- Traverse T4-1 = + 100 mm
 Traverse T5-1 = + 95 mm
 Traverse T6-1 = + 55 mm
 Traverse T4-2 = + 145 mm
 Traverse T5-2 = + 140 mm
 Traverse T6-2 = + 90 mm
 S200 = + 65 mm

Rollentyp

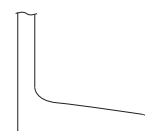

Konisch/
Schräg

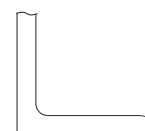

Zylindrisch/
Gerade

Bitte beachten: Der Käufer trägt die volle Verantwortung für eine korrekte Bemaßung der Grube. Außerdem muss die Grube genügend verankert und für die gewünschte Belastung konstruiert sein.

Datum:

Maßangaben von:

Händler:

Unterschrift:

PLAN DE MESURE PONT

FL - traverse de levage 6 t 12 t 16 t 20 t

SD - traverse de levage 2 t 2,6 t 3,2 t 4 t

Fabricant de l'élévateur : _____ Modèle : _____ Capacité : _____ Année : _____

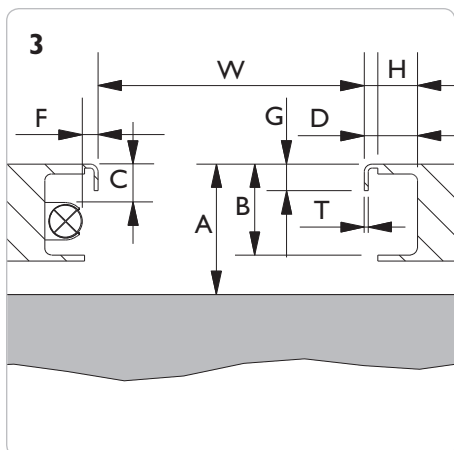
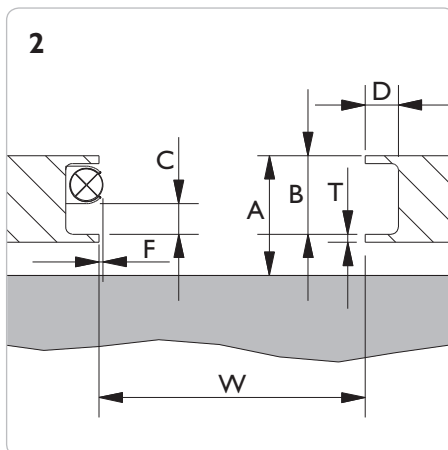
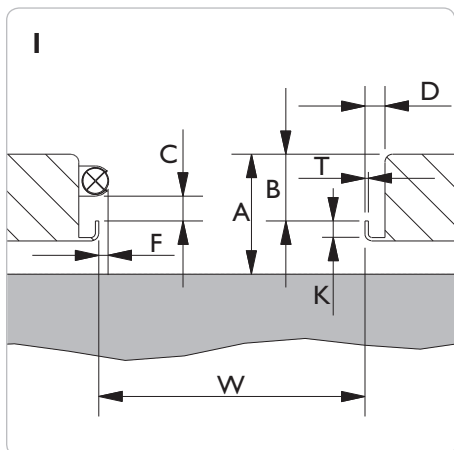

4 Plan

Plan n° : _____

W = _____ mm

A = _____ mm

B = _____ mm

D = _____ mm

G = _____ mm

H = _____ mm

K = _____ mm

T = _____ mm

Si l'élévateur est muni de lampes  ou d'autres objets en saillie, complétez les dimensions C et F:

C min. = _____ mm

F max. = _____ mm

Profilé de rail

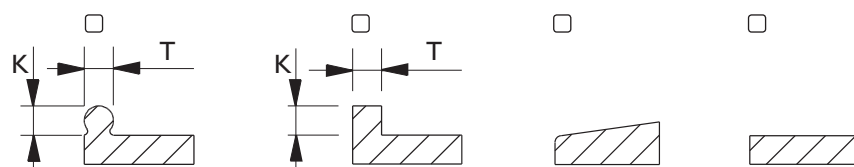

NB ! Il incombe à l'acheteur de veiller à ce que les données indiquées soient correctes et complètes. L'élévateur doit toujours être conçu et homologué pour le montage d'un cric auxiliaire. **En application de la norme EN1493:1998, la capacité du cric auxiliaire ne peut pas dépasser 0,66 x la capacité de l'élévateur** (un cric de 2 tonnes peut être monté sur un élévateur de 3 tonnes, mais pas de 2,6 tonnes).

Date : _____

Mesuré par : _____

Distributeur : _____

Signature : _____

PLAN DE MESURE FOSSE

- | | | | | | | | | |
|---|-------------------------------|-------------------------------|-------------------------------|----------------------------------|-------------------------------|--------------------------------|--------------------------------|-------------------------------|
| GD - cric de fosse | <input type="checkbox"/> 10 t | <input type="checkbox"/> 15 t | <input type="checkbox"/> 20 t | FL - traverse de levage | <input type="checkbox"/> 6 t | <input type="checkbox"/> 12 t | <input type="checkbox"/> 16 t | <input type="checkbox"/> 20 t |
| GDT - cric de fosse Télescopique | <input type="checkbox"/> 15 t | | | SD - traverse de levage | <input type="checkbox"/> 2 t | <input type="checkbox"/> 2,6 t | <input type="checkbox"/> 3,2 t | <input type="checkbox"/> 4 t |
| GGD - cric de fosse | <input type="checkbox"/> 15 t | | | ABT - traverse de soutien | <input type="checkbox"/> 20 t | | | |
| AB - traverse de soutien | <input type="checkbox"/> 20 t | | | | | | | |

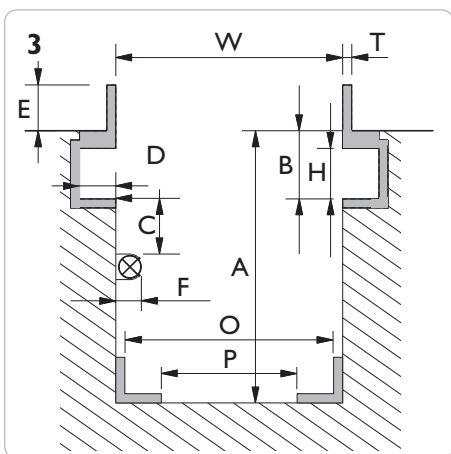
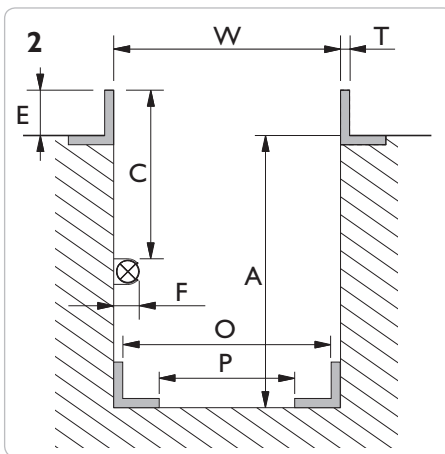
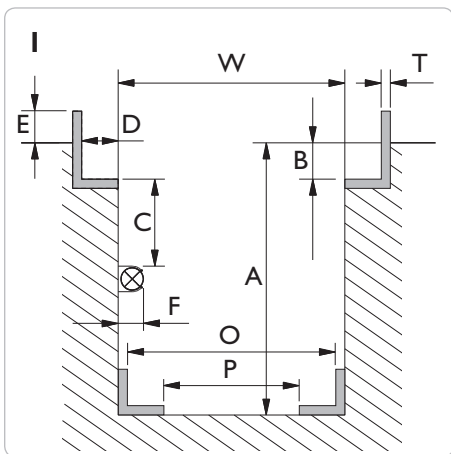

4 Plan

Plan n°: _____

Mesurez minutieusement à plusieurs endroits dans la fosse. **NB!** Écart maxi de 12 mm entre W min. et W max. sur toute la longueur de la fosse

W min. = _____ mm

W max. = _____ mm

A min. = _____ mm

B = _____ mm

D = _____ mm

E = _____ mm

H = _____ mm

T = _____ mm

Si la fosse est munie de lampes ou d'autres objets en saillie, complétez les dimensions C et F:

C min. = _____ mm

F max. = _____ mm

GGDI50S - cric de fosse

O min. = _____ mm

O max. = _____ mm

P min. = _____ mm

P max. = _____ mm

Hauteur par rapport au sol

Bord supérieur de la selle de levage **sans** accessoire (traverse, support ou rehausse) souhaité :

- au-dessus du sol de l'atelier
- au niveau du sol de l'atelier
- sous le sol de l'atelier

La tête du vérin sera positionnée +/- 50 mm selon niveau souhaité

Accessoire

Il est à noter que le montage d'une traverse ou d'un support accroît, le cas échéant, la hauteur minimum :

- Traverse T4-1 = + 100 mm
- Traverse T5-1 = + 95 mm
- Traverse T6-1 = + 55 mm
- Traverse T4-2 = + 145 mm
- Traverse T5-2 = + 140 mm
- Traverse T6-2 = + 90 mm
- S200 = + 65 mm

Type de galet / profilé de rail

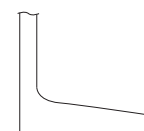

Conique/
incliné

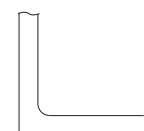

Cylindrique/
plan

NB! Il incombe à l'acheteur de veiller à ce que les données indiquées soient correctes et complètes et à ce que la fosse soit conçue pour la capacité souhaitée et suffisamment ancrée en vue de celle-ci.

Date :

Mesuré par :

Distributeur :

Signature :